

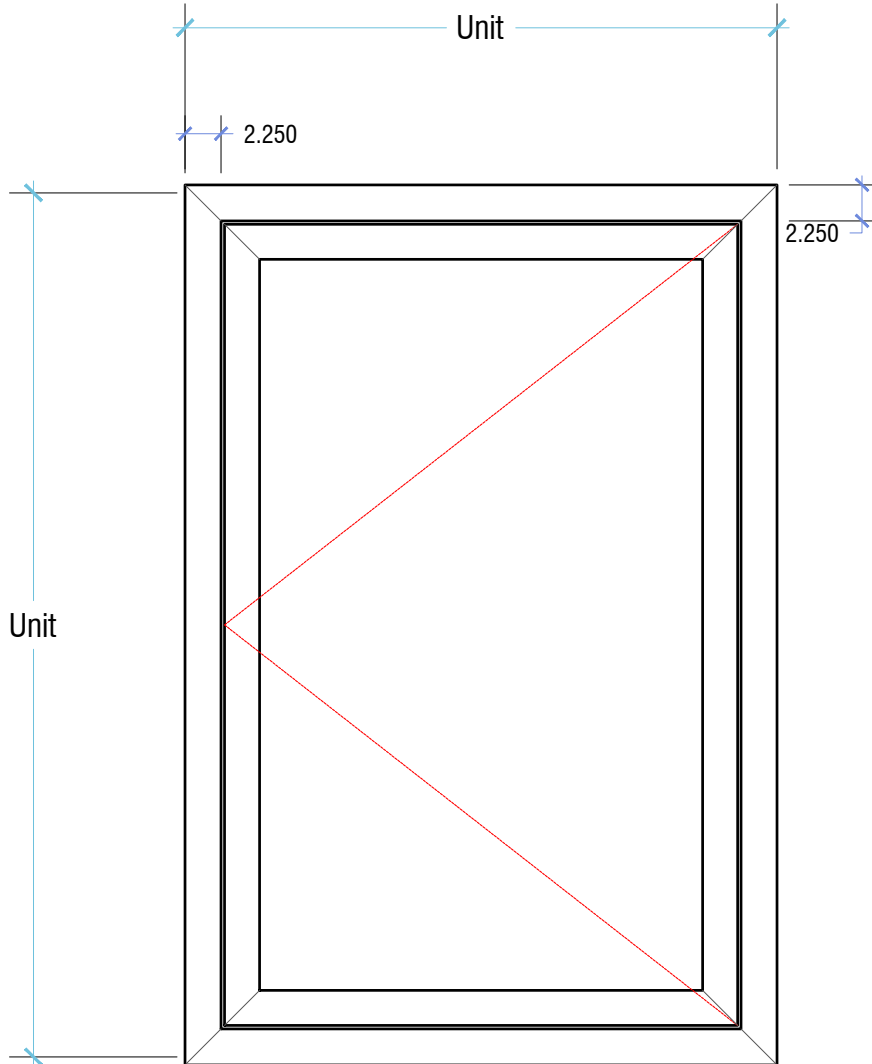

7463 Research Dr  
Almont MI 48003  
810-798-2817 ph  
810-798-3814 fx

Custom Design • Restoration • Reproduction



Copyright 2017, Grabill Window & Doors, Inc.

1" = 1'-0"

---

## 2.25" ALUMINUM CLAD OUTSWING OPERABLE ELEVATION

Sales Binder

[www.grabillwindow.com](http://www.grabillwindow.com)

*Grabill Architectural Drawings contain confidential and proprietary information and is for the sole use of the intended recipient(s).*

*Any unauthorized review, use, disclosure or distribution of these drawing (including attachments) is strictly prohibited.*



7463 Research Dr  
Almont MI 48003  
810-798-2817 ph  
810-798-3814 fx

Custom Design • Restoration • Reproduction

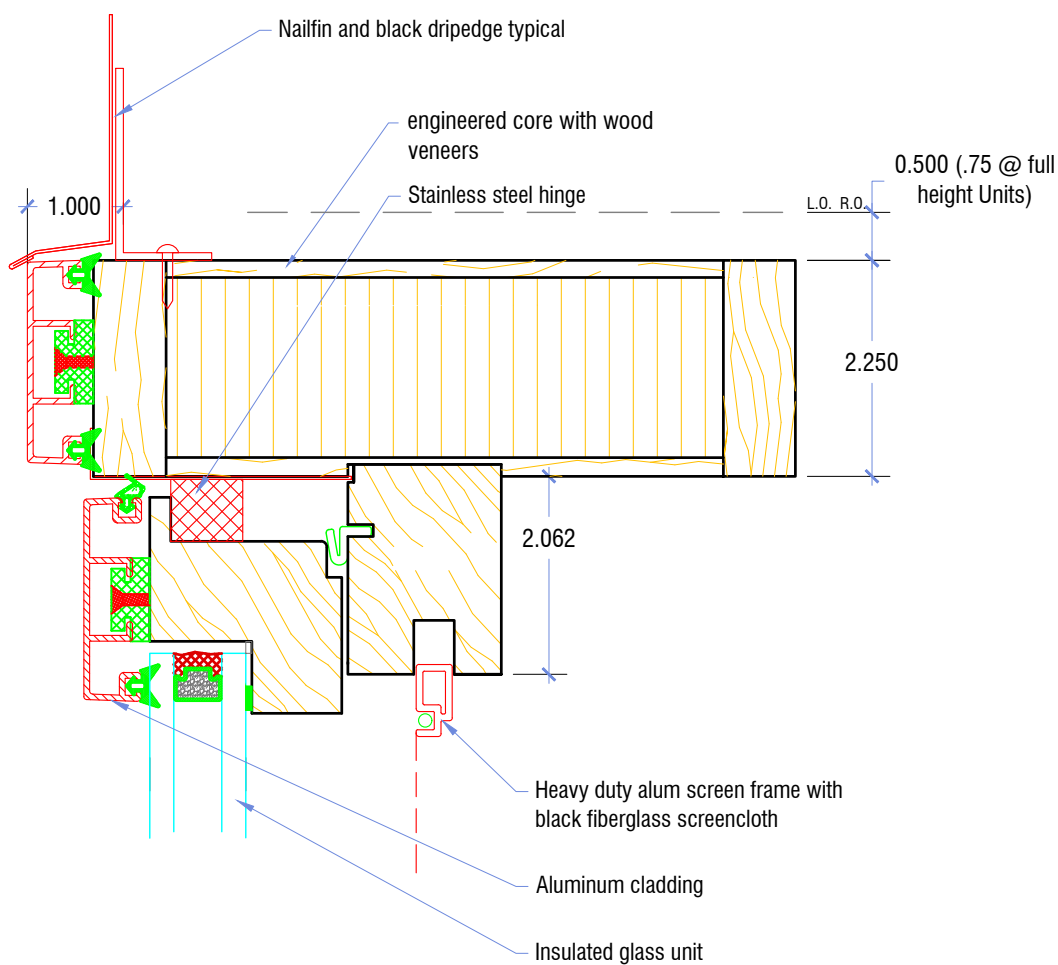

Copyright 2017, Grabill Window & Doors, Inc.

6" = 1'-0"

## 2.25" ALUMINUM CLAD OUTSWING OPERABLE SASH AT HEAD

*Grabill Architectural Drawings contain confidential and proprietary information and is for the sole use of the intended recipient(s).*

*Any unauthorized review, use, disclosure or distribution of these drawing (including attachments) is strictly prohibited.*

Sales Binder

[www.grabillwindow.com](http://www.grabillwindow.com)



7463 Research Dr  
 Almont MI 48003  
 810-798-2817 ph  
 810-798-3814 fx

Custom Design • Restoration • Reproduction

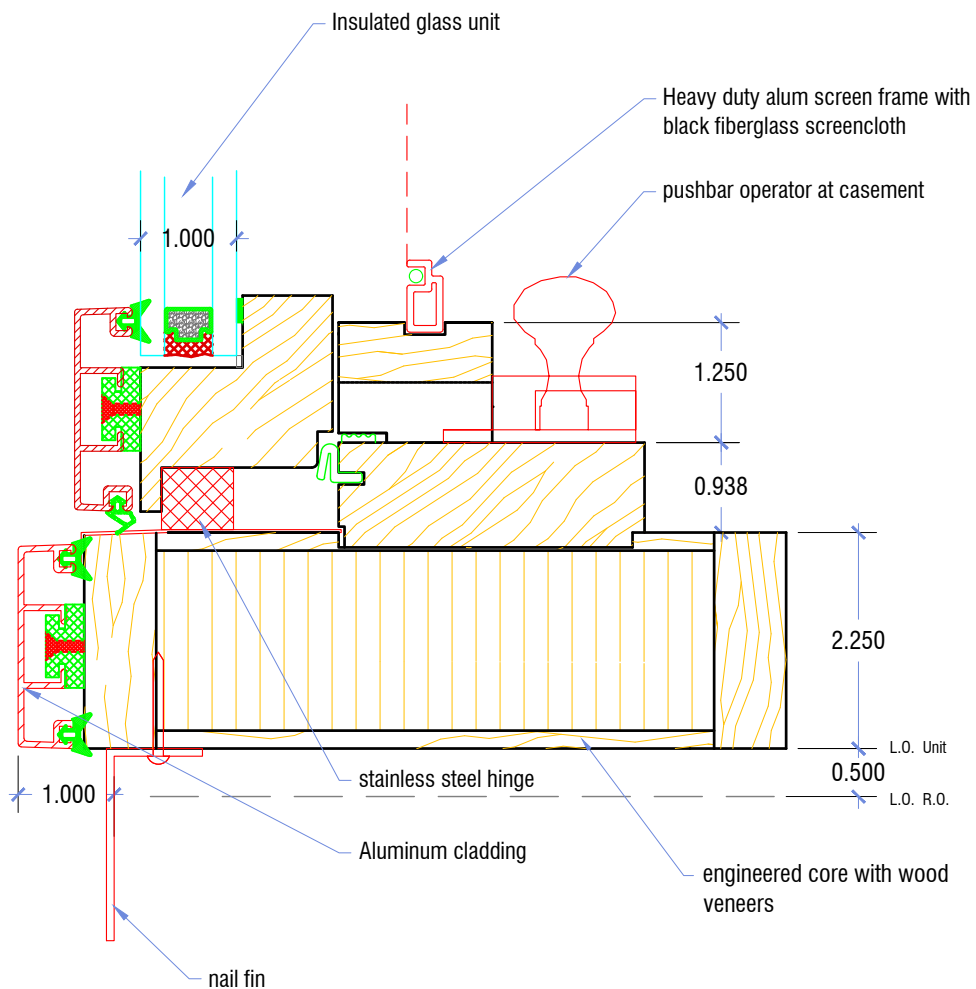

Copyright 2017, Grabill Window & Doors, Inc.

6" = 1'-0"

2.25" ALUMINUM CLAD OUTSWING OPERABLE SASH AT SILL

*Grabill Architectural Drawings contain confidential and proprietary information and is for the sole use of the intended recipient(s).*

*Any unauthorized review, use, disclosure or distribution of these drawing (including attachments) is strictly prohibited.*

Sales Binder

www.grabillwindow.com



7463 Research Dr  
 Almont MI 48003  
 810-798-2817 ph  
 810-798-3814 fx

Custom Design • Restoration • Reproduction

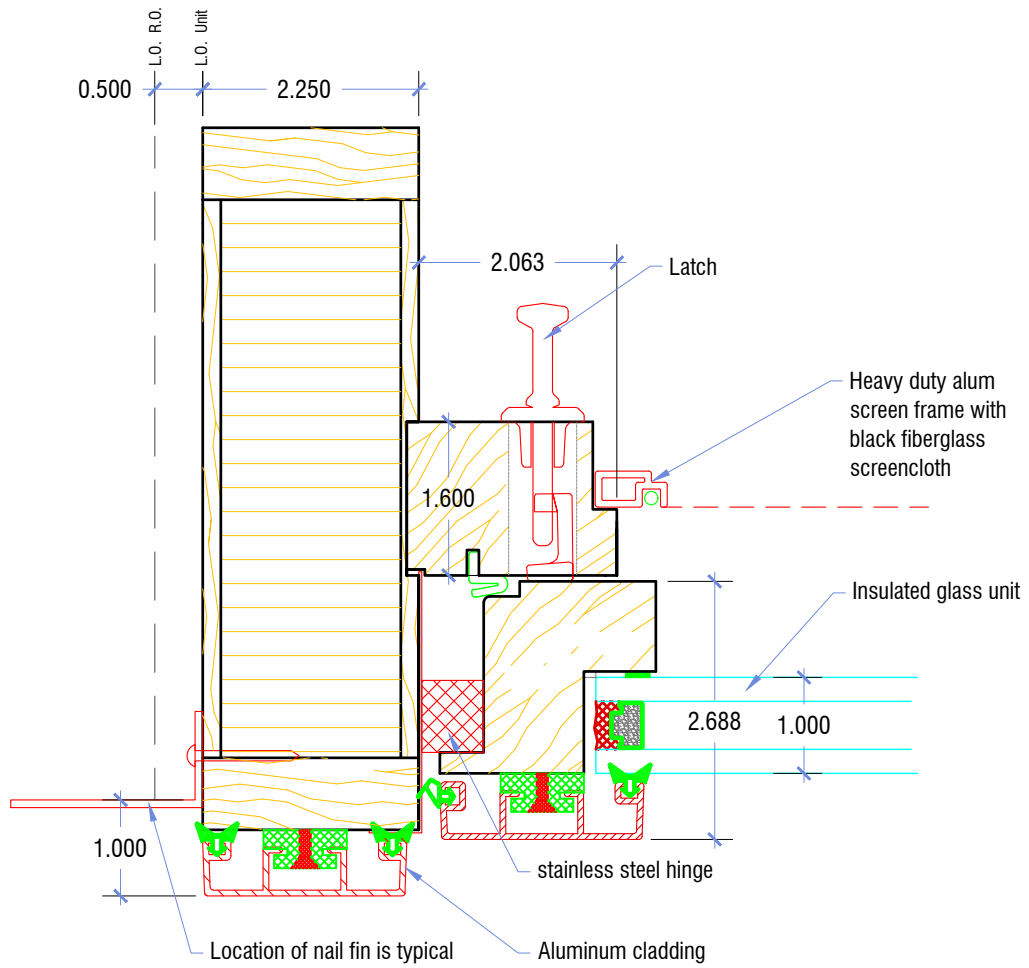

Copyright 2017, Grabill Window & Doors, Inc.

$$6'' = 1'-0''$$

2.25" ALUMINUM CLAD OUTSWING OPERABLE SASH AT SIDE JAMB

*Grabill Architectural Drawings contain confidential and proprietary information and is for the sole use of the intended recipient(s).*

*Any unauthorized review, use, disclosure or distribution of these drawing (including attachments) is strictly prohibited.*

Sales Binder

www.grabillwindow.com



7463 Research Dr  
Almont MI 48003  
810-798-2817 ph  
810-798-3814 fx

Custom Design • Restoration • Reproduction

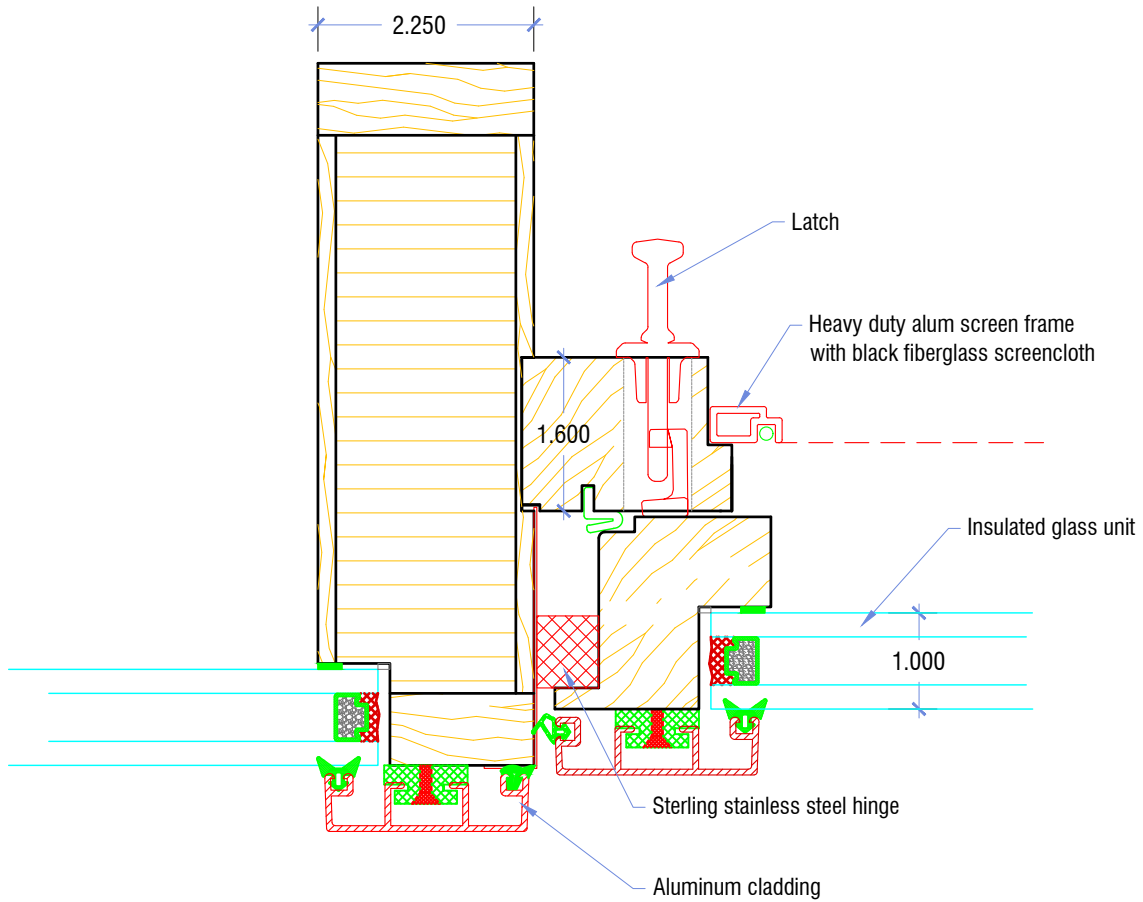

Copyright 2017, Grabill Window & Doors, Inc.

6" = 1'-0"

2.25" ALUMINUM CLAD OUTSWING OPERABLE SASH /  
DIRECT SET COMMON MULLION

Grabill Architectural Drawings contain confidential and proprietary information and is for the sole use of the intended recipient(s).

Any unauthorized review, use, disclosure or distribution of these drawing (including attachments) is strictly prohibited.

Sales Binder

www.grabillwindow.com



7463 Research Dr  
Almont MI 48003  
810-798-2817 ph  
810-798-3814 fx

Custom Design • Restoration • Reproduction

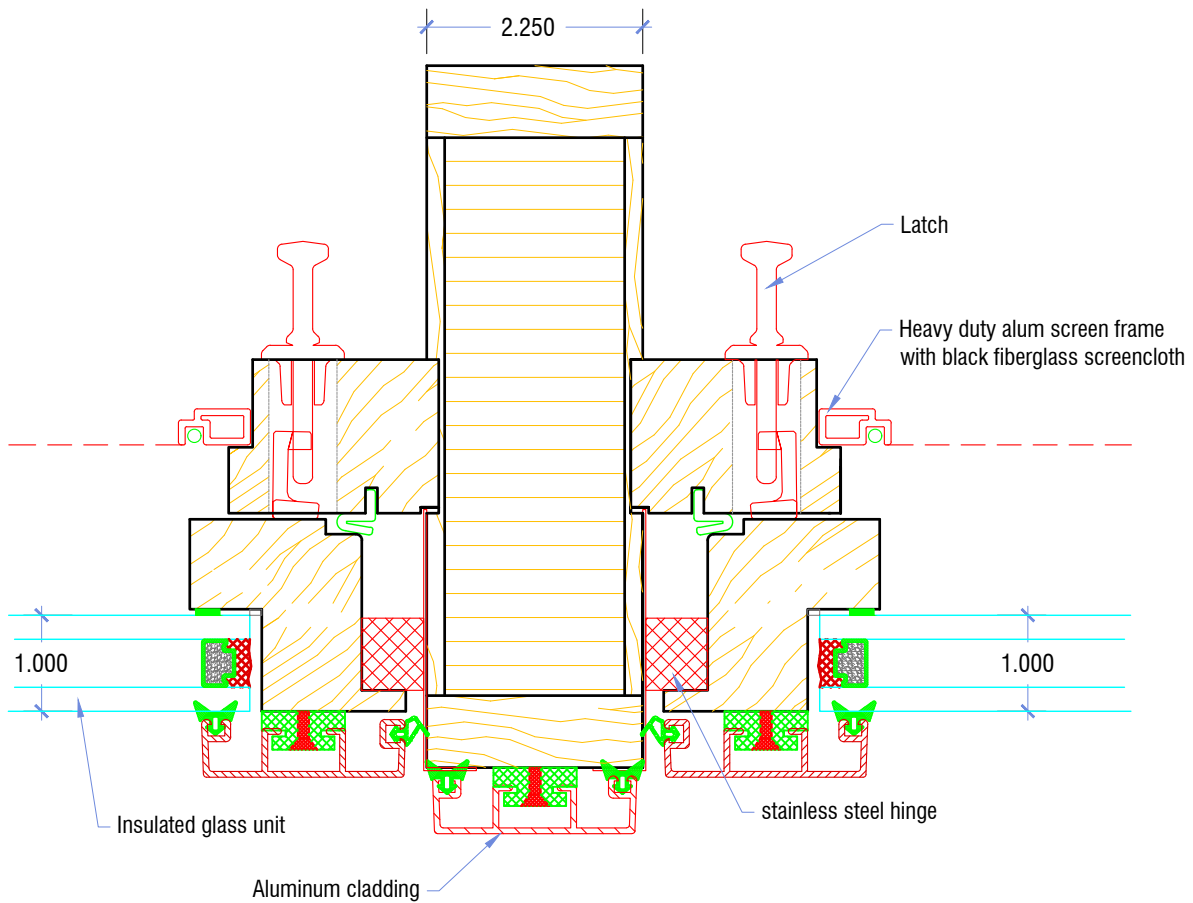

Copyright 2017, Grabill Window & Doors, Inc.

6" = 1'-0"

1.75" ALUMINUM CLAD OUTSWING OPERABLE SASH /  
OUTSWING OPERABLE SASH COMMON MULLION

*Grabill Architectural Drawings contain confidential and proprietary information and is for the sole use of the intended recipient(s).*

*Any unauthorized review, use, disclosure or distribution of these drawing (including attachments) is strictly prohibited.*

Sales Binder

[www.grabillwindow.com](http://www.grabillwindow.com)



7463 Research Dr  
 Almont MI 48003  
 810-798-2817 ph  
 810-798-3814 fx

Custom Design • Restoration • Reproduction

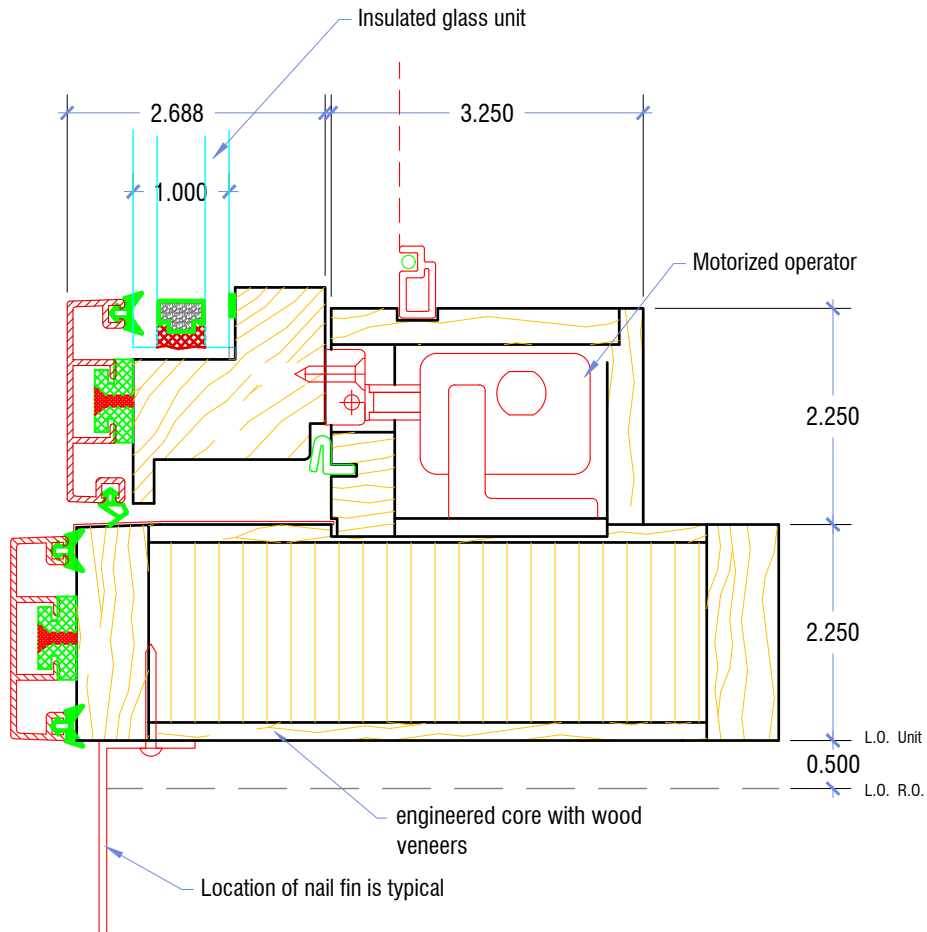

Copyright 2017, Grabill Window & Doors, Inc.

$$6'' = 1'-0''$$

## 2.25" ALUMINUM GLAD MOTORIZED OUTSWING AWNING AT SILL

*Grabill Architectural Drawings contain confidential and proprietary information and is for the sole use of the intended recipient(s).*

*Any unauthorized review, use, disclosure or distribution of these drawing (including attachments) is strictly prohibited.*

Sales Binder

www.grabillwindow.com